

ESQUEMA DE MONTAGEM

PRODUTO
COZINHA LILIAN

CÓDIGO
2012150

MARTELO

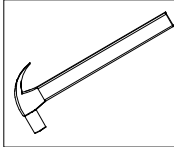

CHAVE PHILIPS

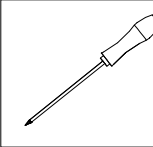

PARAFUSADEIRA



GARANTIA
90
DIAS

-EM CASO DE ASSISTÊNCIA INDICAR O CÓDIGO DO PRODUTO, CÓDIGO DA COR E O CÓDIGO DA PEÇA DANIFICADA

| CORES |
|---|
| CÓD. DESCRIÇÃO 926 ATACAMA/GRAFITE 910 - ATACAMA / OFFWHITE |

| DIMENSÕES DO PRODUTO |
|---|
| LARGURA:2108mm ALTURA:2000mm PROFUNDIDADE:288mm |

ASPECTO FINAL

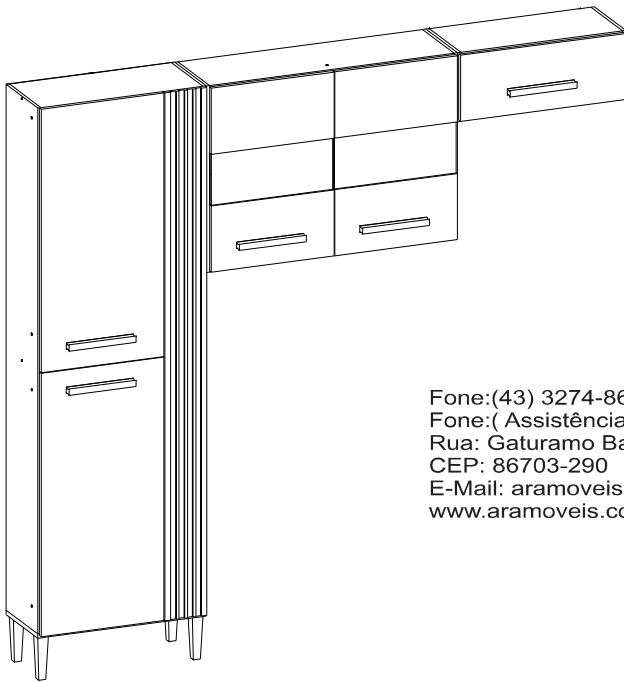



















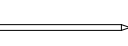

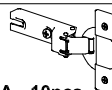
| REFERÊNCIA910 ATACAMA / OFF-WHITE | REFERÊNCIA926 ATACAMA/GRAFITE | MEDIDAS E DESCRIÇÃO | QTDE. |
|--------------------------------------|----------------------------------|-------------------------------------|-------|
| 215029/900 | 215029/900 | LAT DIR PAN- 1830 X 270 X 12 | 1 |
| 215030/900 | 215030/900 | LAT ESQ PAN - 1830 X 270 X 12 | 1 |
| 215031/901 | 215031/926 | PORTA PAN - 0917 X 440 X 15 | 2 |
| 215032/900 | 215032/900 | VISTA ACABAMENTO - 1837 X 150 X 15 | 1 |
| 215033/900 | 215033/900 | LAT DIR/ESQ ARM - 0650 X 270 X 12 | 2 |
| 215035/900 | 215035/900 | CHAPEU/BASE ARM - 0876 X 270 X 15 | 2 |
| 215034/900 | 215034/900 | PRAT ARM - 0876 X 210 X 15 | 1 |
| 215036/900 | 215036/900 | COLUNA - 0620 X 060 X 15 | 1 |
| 190035/900 | 190035/900 | BASE C/ PÉ - 0604 X 270 X 15 | 1 |
| 211325/900 | 211325/900 | LAT ESQ - 0270 X 240 X 12 | 1 |
| 215038/900 | 215038/900 | LAT DIR REF- 0270 X 240 X 12 | 1 |
| 215040-901 | 215040/926 | PORTA REF - 0595 X 230 X 15 | 1 |
| 215039-900 | 215039/900 | CHAPÉU REF - 0580 X 270 X 15 | 1 |
| 707922/900 | 707922/900 | BASE REFRIGERADOR - 0580 X 270 X 15 | 5 |
| 210021/900 | 210021/900 | PUXADOR MAD - 0240 X 025 X 25 | 5 |
| 215008/900 | 215008/900 | FUNDO REF - 0600 X 235 X 03 | 1 |
| 215007/900 | 215007/900 | FUNDO ARM - 0897 X 321 X 03 | 2 |
| 215006/900 | 215006/900 | FUNDO PAN - 1845 X 296 X 03 | 2 |
| 215041/910 | 215041/926 | PORTA DE VIDRO DIR - 640 X 440 X 15 | 1 |
| 215042/910 | 215042/926 | PORTA DE VIDRO ESQ - 640 X 440 X 15 | 1 |

Fone:(43) 3274-8600 Fax (43) 3274-8601
Fone:(Assistência Técnica) 0800 707 2455
Rua: Gaturamo Bandeira 145 - Pq Industrial 2
CEP: 86703-290 Arapongas - Paraná
E-Mail: aramoveis@aramoveis.com.br
www.aramoveis.com.br

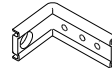
aramoveis

Depósito Guarulhos-SP
Rua: Junqueiro, Nº 298 CEP: 07210-130
Jardim Arapongas (Estrada velha de São Miguel)
Fone:(11) 4803-4691
Fone:(11) 4803-4697
Whats: (43) 99914-0493
aramoveissp@aramoveis.com.br

OS PARAFUSOS ESTÃO ESCALA DE TAMANHO REAL PARA MELHOR IDENTIFICAÇÃO

| | | | |
|--|---|---|---|
|  A - 32006 PARAFUSO 3.5X12MM - 58pçs |  B - 32008 PARAFUSO 3.5X16MM - 2pçs |  C - 32038 PARAFUSO MAQ4X25MM - 8pç |  D - 32048 PARAFUSO 3.0X30MM - 10pç |
|  E - 32005 PARAFUSO 4.0X45MM - 18pç |  F - 32051 PARAFUSO 5.0X40MM - 4pç |  G - 32013 PARAFUSO 6.0X60MM - 6pçs |  H - 45000 CAVILHA 6.0X30MM - 38pç |
|  I - 32004 PREGO 08X08MM - 130pç |  J - 37002 PORCA CILINDRICA - 4pçs |  K - 38006 DOBRADIÇA - 10pçs |  L - 38007 CALÇO 5MM - 10pçs |
|  M - 38010 UNIÃO DE FUNDO - 9pç |  N - 38013 CANTONEIRA - 6pçs |  O - 38002 CANTONEIRA DE PAREDE - 6pçs |  P - 37012 BUCHA DE FIXAÇÃO - 6pçs |
|  Q - 32018 PORCA SEXTAVADA 4MM - 8pç |  R - 46022 BOTÃO TAPA FURO - 12pç |  S - 40914 PÉ PLÁSTICO QUADRADO 156MM - 4pçs |  U - 46246 PERFIL H 1815MM - 1pçs |
|  V - 38000 LIMITADOR ARTICULADO DIR. - 1pçs | | | |

MONTAGEM PASSO A PASSO

- 1° - É ACONSELHÁVEL FORRAR O CHÃO PARA MONTAGEM;
- 2° - É ACONSELHÁVEL MONTAR O PRODUTO DEITADO ONDE A FRENTE DO MESMO FIQUE PARA BAIXO;
- 3° - MONTAR TODAS AS PARTES CONFORME O ESQUEMA DE MONTAGEM;
- 4° - AS PORTAS E RODATETO SÃO AS ÚLTIMAS A SER FIXADAS;
- 5° - É NECESSÁRIO 02 PESSOAS PARA MONTAGEM.

1° - PREPARAÇÃO DAS PEÇAS

OBS: DEFINIR QUAL LADO A PORTA VAI ABRIR ATRAVÉS DA LATERAL 215029 - 215030 - VER PAGINA 03

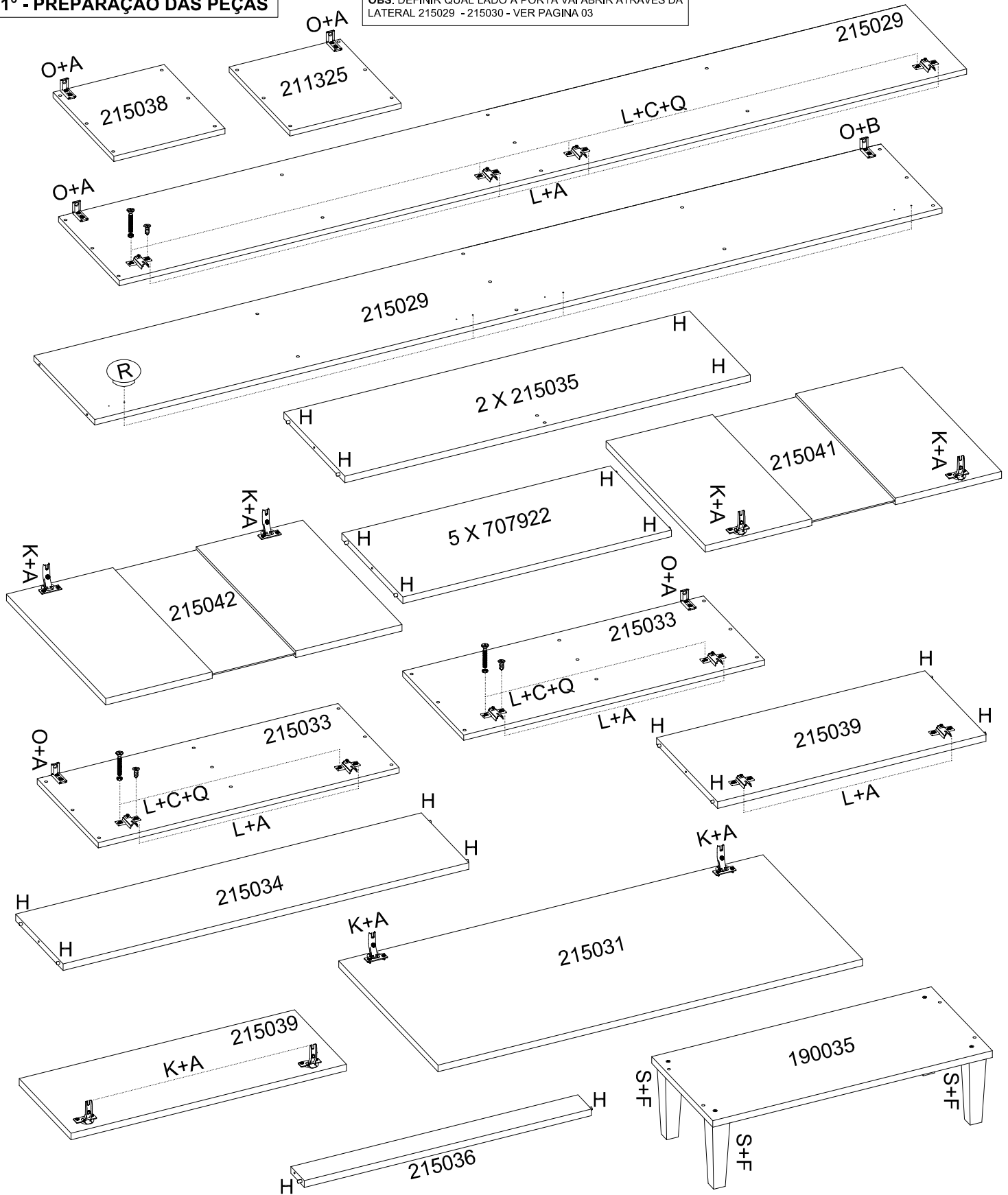

ESCOLHER LADO DA ABERTURA DA PORTA

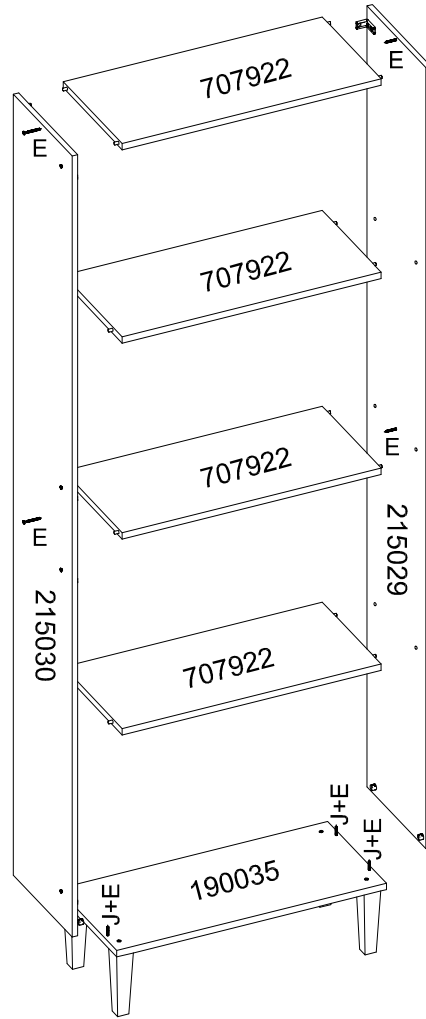
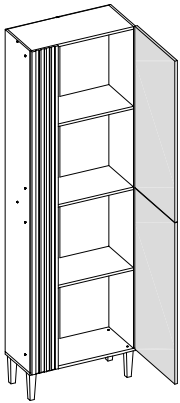
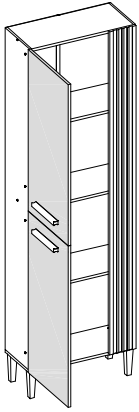

2° - MONTAGEM PANELEIRO E AEREOS

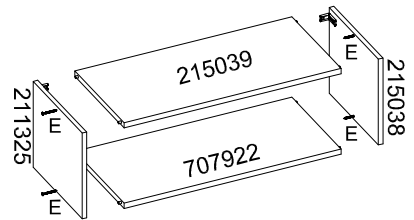
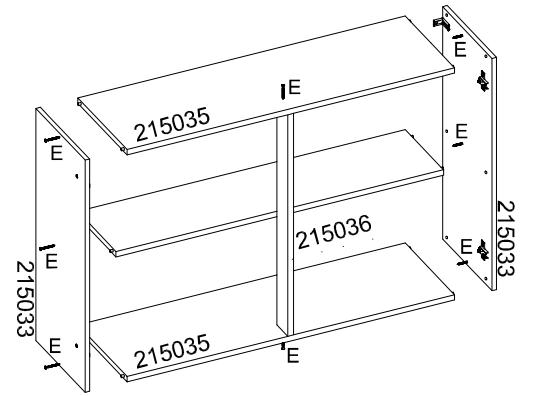

3° - FIXAÇÃO DOS FUNDOS

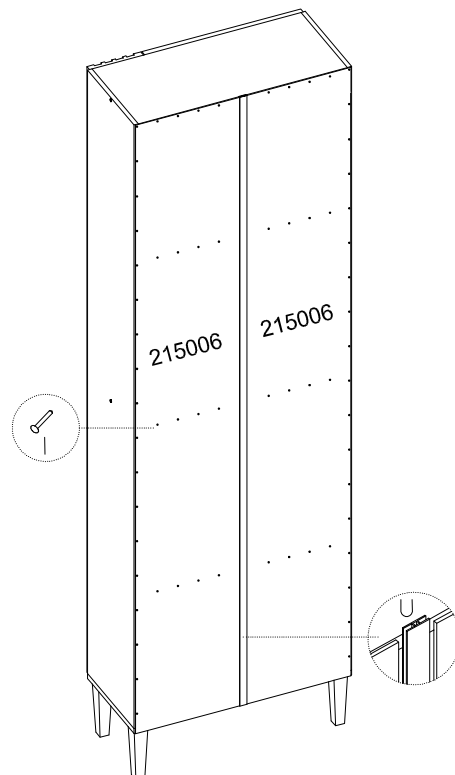
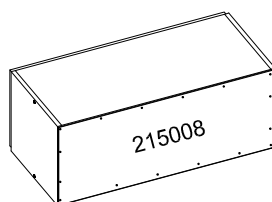
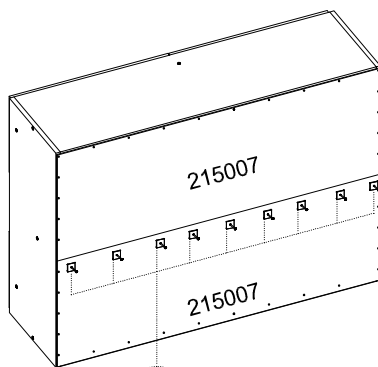

4° - COLOCAÇÃO DAS PORTAS E VISTA ACABAMENTO

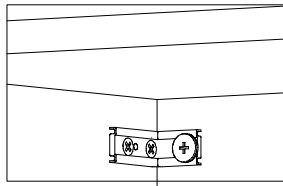

6 X O+G+P



N+A

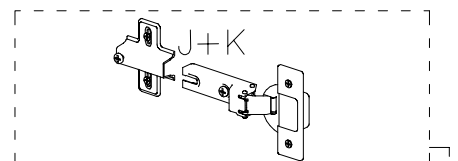
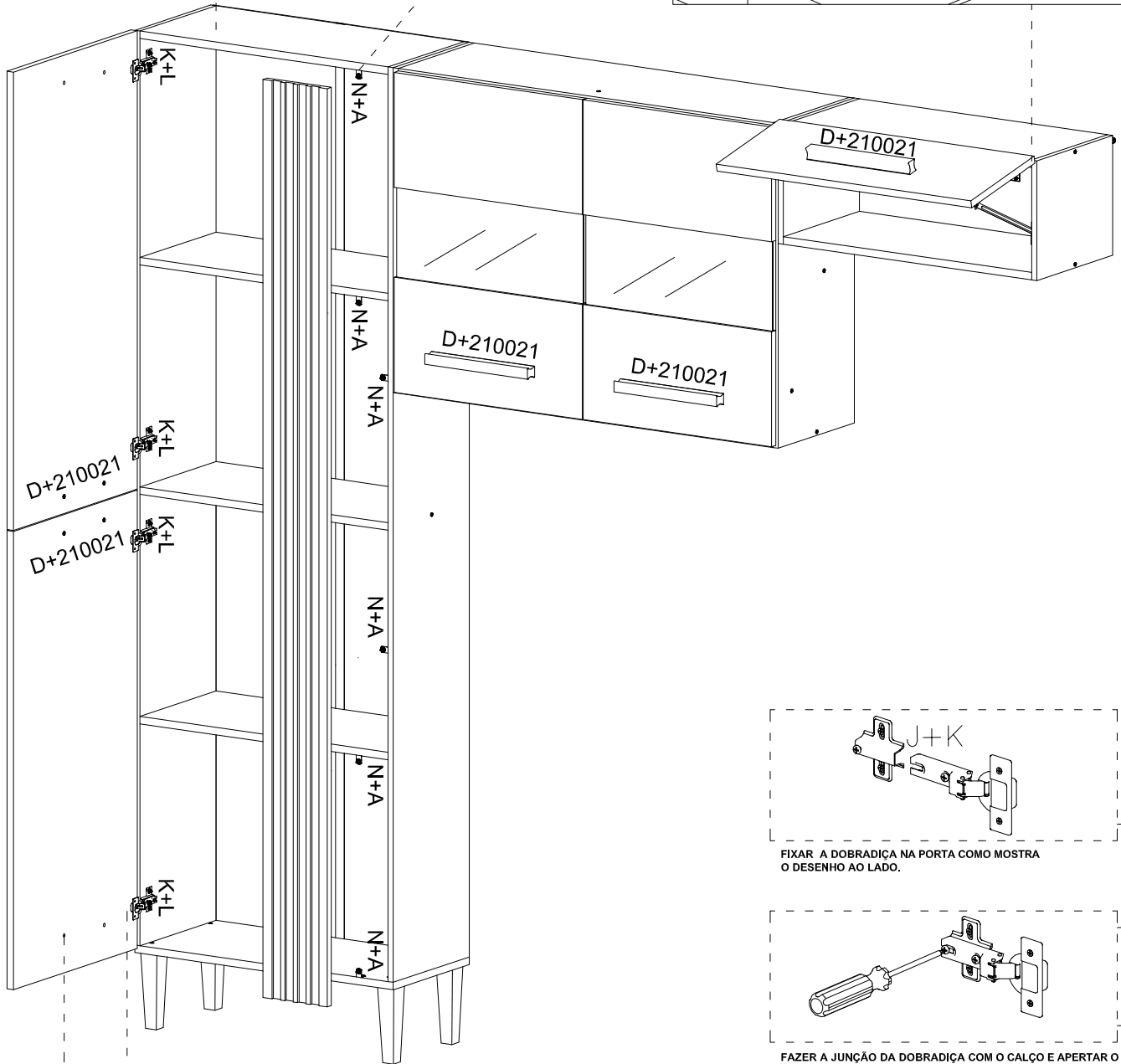
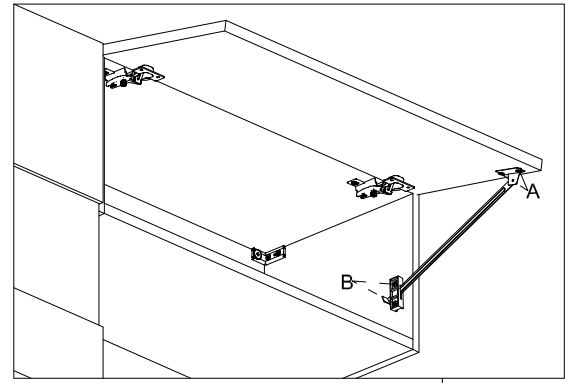

FIXAR A DOBRADIÇA NA PORTA COMO MOSTRA O DESENHO AO LADO.

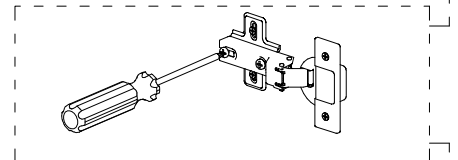

FAZER A JUNÇÃO DA DOBRADIÇA COM O CALÇO E APERTAR O PARAFUSO CENTRAL.

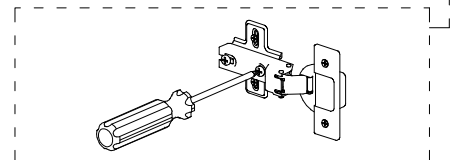

APÓS A JUNÇÃO FECHAR A PORTA E FAZER A REGULAGEM PRECISA.

RO