

# ESQUEMA DE MONTAGEM

**PRODUTO**  
PANELEIRO 04 PTS 01 GAV  
CLARA PLUS

**CÓDIGO**  
2002101

MARTELO

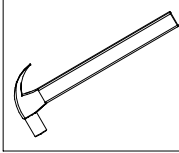

CHAVE PHILIPS

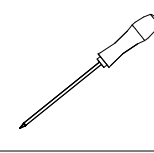

PARAFUSADEIRA

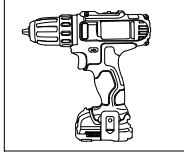

**GARANTIA**  
**90**  
**DIAS**

-EM CASO DE ASSISTÊNCIA INDICAR O CÓDIGO DO PRODUTO, CÓDIGO DA COR E O CÓDIGO DA PEÇA DANIFICADA

REFERÊNCIA 908 ATACAMA / PRETO FOSCO	REFERÊNCIA 930 ATACAMA / BRANCO TX NOVO	REFERÊNCIA 910 ATACAMA / OFF-WHITE	MEDIDAS E DESCRIÇÃO	QTDE.
212028/900	212028/900	212028/900	LATERAL DIR PAN DUPLO - 1900 X 360 X 12	1
212029/900	212029/900	212029/900	LATERAL ESQ PAN DUPLO - 1900 X 360 X 12	1
212024/908	212024/505	212024/901	PORTA INF PAN - 0590 X 292 X 15	2
212025/908	212025/505	212025/901	PORTA SUPERIOR PAN - 0390 X 292 X 15	2
200150/900	200150/900	200150/900	PRAT PAN DUPLO - 0580 X 360 X 15	1
200151/900	200151/900	200151/900	BASE / CHAPÉU PAN DUPLO - 0580 X 360 X 15	2
200140/900	200140/900	200140/900	VISTA FRONTAL PAN DUPLO - 0580 X 080 X 15	1
200139/999	200139/999	200139/999	VISTA TRASEIRA PAN DUPLO - 0580 X 080 X 15	1
200156/900	200156/900	200156/900	BASE C/PÉ PAN DUPLO - 0605 X 360 X 15	1
200105/900	200105/900	200105/900	FUNDO INF TRAS PAN DUPLO - 0620 X 295 X 03	2
212002/900	212002/900	212002/900	FUNDO GAVETA - 0552 X 345 X 03	1
212001/900	212001/900	212001/900	FUNDO SUP TRAS PAN - 1265 X 295 X 03	2
212023/900	212023/505	212023/901	FRENTE GAVETA - 0590 X 145 X 15	1
200145/900	200145/900	200145/900	CONTRA FUNDO PAN DUPLO - 0531 X 080 X 15	1
130624/900	130624/900	130624/900	LATERAL GAV - 0340 X 095 X 12	2
211024-900	211024-900	211024-900	PRATELEIRA INFERIOR - 580 X 270 X 15	1

## ASPECTO FINAL

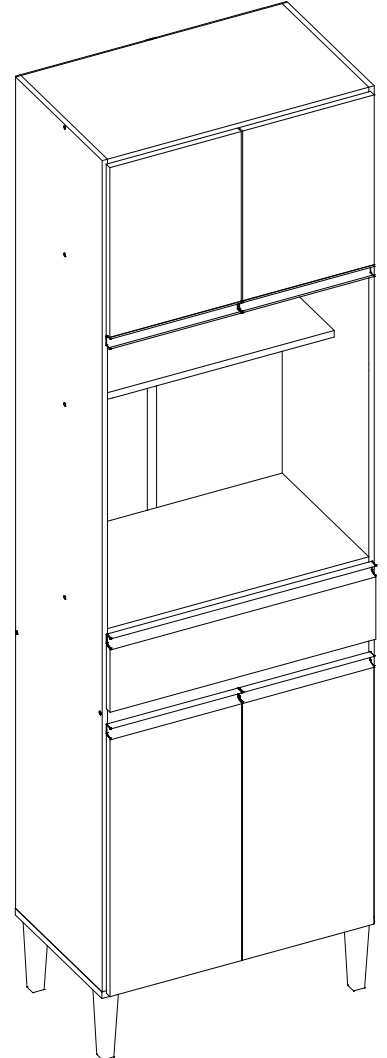

### CORES

**CÓD. DESCRIÇÃO**  
908 - ATACAMA / PRETO FOSCO  
930 - ATACAMA / BRANCO TX NOVO  
910 - ATACAMA / OFFWHITE

### DIMENSÕES DO PRODUTO















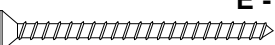
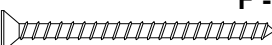

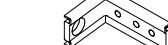
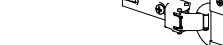

LARGURA:2070mm  
ALTURA:605mm  
PROFUNDIDADE:378mm



Depósito Guarulhos-SP  
Rua: Junqueiro, N° 298 CEP: 07210-130  
Jardim Arapongas (Estrada Velha de São Miguel)  
Fone: (11) 4803-4691  
Fone: (11) 4803-4697  
Whats: (43) 99914-0493  
aramoveissp@aramoveis.com.br

Fone:(43) 3274-8600 Fax (43) 3274-8601  
Fone:(Assistência Técnica) 0800 707 2455  
Rua: Gaturamo Bandeira 145 - Pq Industrial 2  
CEP: 86703-290 Arapongas - Paraná  
E-Mail: aramoveis@aramoveis.com.br  
www.aramoveis.com.br

## OS PARAFUSOS ESTÃO ESCALA DE TAMANHO REAL PARA MELHOR IDENTIFICAÇÃO

 <b>A - 32036</b> PARAFUSO 3.5X12MM CAB.6.0 - 08pçs	 <b>B - 32006</b> PARAFUSO 3.5X12MM CAB. 6.8 - 64pçs	 <b>C - 32009</b> PARAFUSO 4.0X12MM FLAG. - 11pçs	 <b>D - 32048</b> PARAFUSO 3.0X30MM - 4pç
 <b>E - 32005</b> PARAFUSO 4.0X45MM - 14pç	 <b>F - 32051</b> PARAFUSO 5.0X40MM - 4pç	 <b>G - 32013</b> PARAFUSO 6.0X60MM - 2pçs	 <b>H - 32004</b> PREGO 08X08MM - 68pç
 <b>I - 37002</b> PORCA CILINDRICA - 16pçs	 <b>J - 37012</b> BUCHA DE FIXAÇÃO - 2pçs	 <b>K - 38002</b> CANTONEIRA DE PAREDE - 2pçs	 <b>L - 38006</b> DOBRADIÇA - 08pçs
 <b>M - 38007</b> CALÇO 5MM - 08pçs	 <b>N - 38013</b> CANTONEIRA - 2pçs	 <b>O - 45000</b> CAVILHA 6.0X30MM - 26pç	 <b>P - 46307</b> PUXADOR TRILH. PLAST. 590MM - 1pçs
 <b>Q - 46308</b> PUXADOR TRILH. PLAST. 292MM - 4pçs	 <b>R - 40914</b> PÉ PLAST. QUADR. 156MM - 4pçs	 <b>S - 46064</b> PERFIL H 575MM - 1pçs	 <b>U - 46227</b> PERFIL H 1230MM - 1pçs
 <b>V - 38004</b> CORREDIÇA 35CM - 1pçs			

### MONTAGEM PASSO A PASSO

- 1° - É ACONSELHÁVEL FORRAR O CHÃO PARA MONTAGEM;
- 2° - É ACONSELHÁVEL MONTAR O PRODUTO DEITADO ONDE A FRENTE DO MESMO FIQUE PARA BAIXO;
- 3° - MONTAR TODAS AS PARTES CONFORME O ESQUEMA DE MONTAGEM;
- 4° - AS PORTAS E RODAPÉ SÃO AS ÚLTIMAS A SER FIXADAS;
- 5° - É NECESSÁRIO 02 PESSOAS PARA MONTAGEM.

### 1° - PREPARAÇÃO DAS PEÇAS

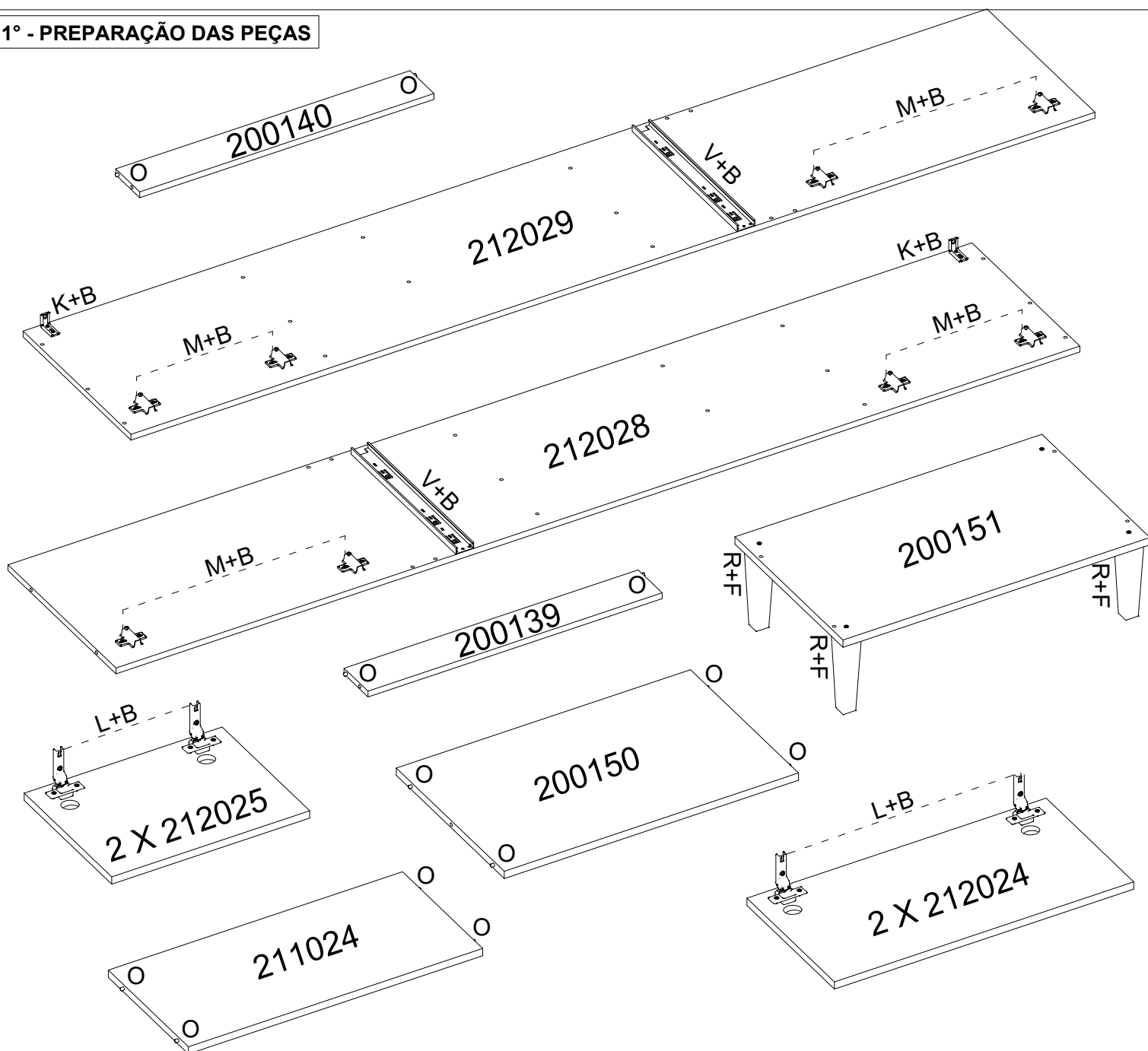

### 5° - MONTAGEM DAS GAVETAS

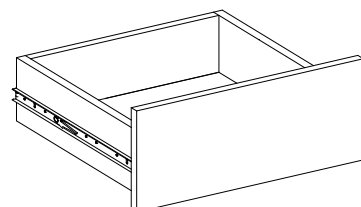
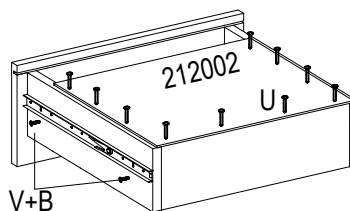
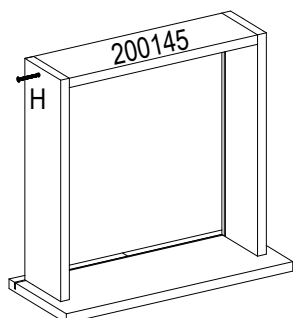
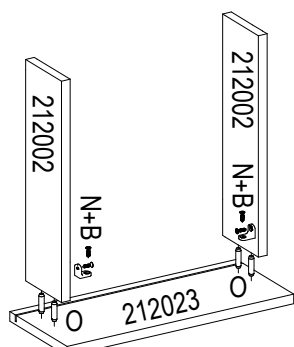

2° - MONTAGEM ESTRUTURA PANELEIRO

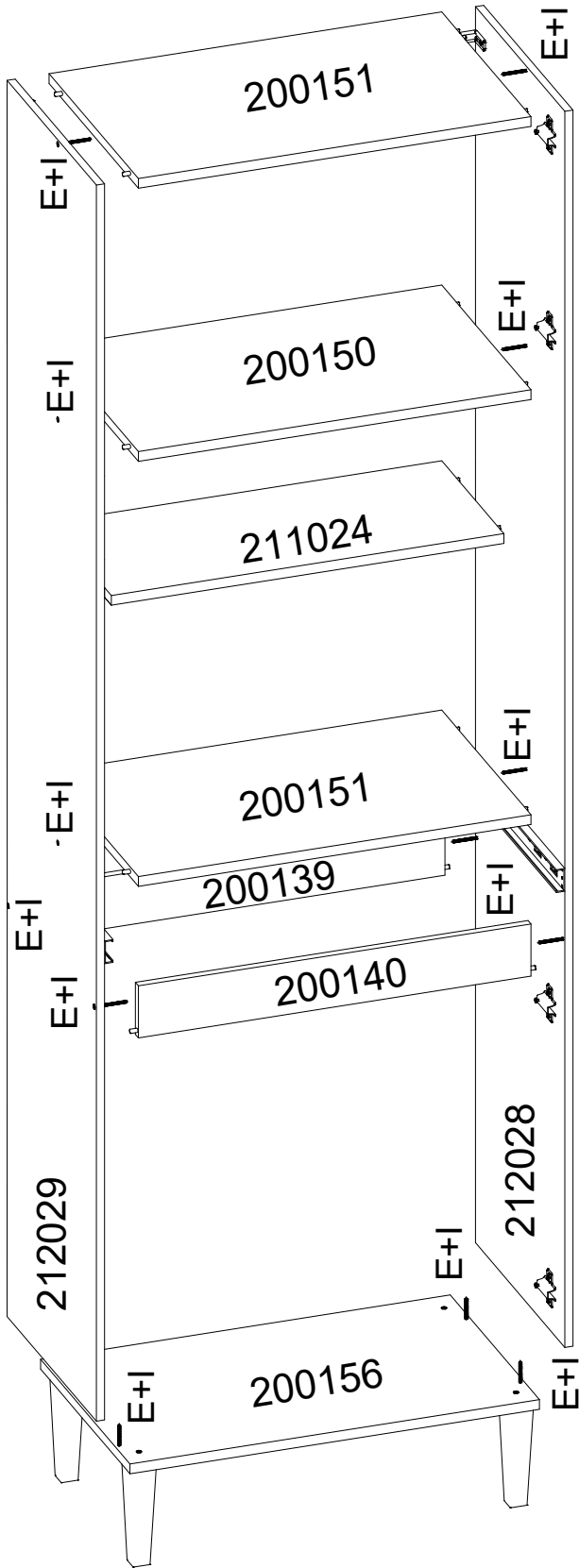

3° - FIXAÇÃO DOS FUNDOS

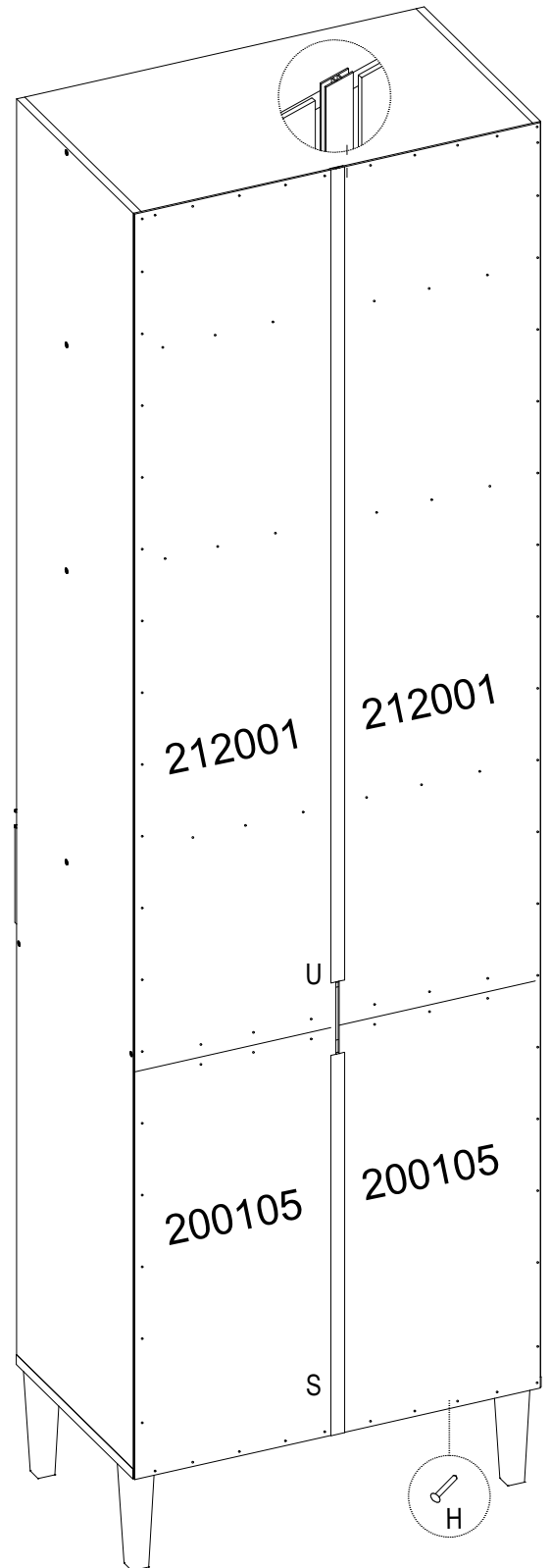

#### 4° - COLOCAÇÃO DAS PORTAS

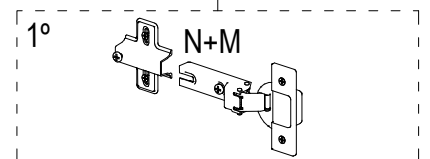
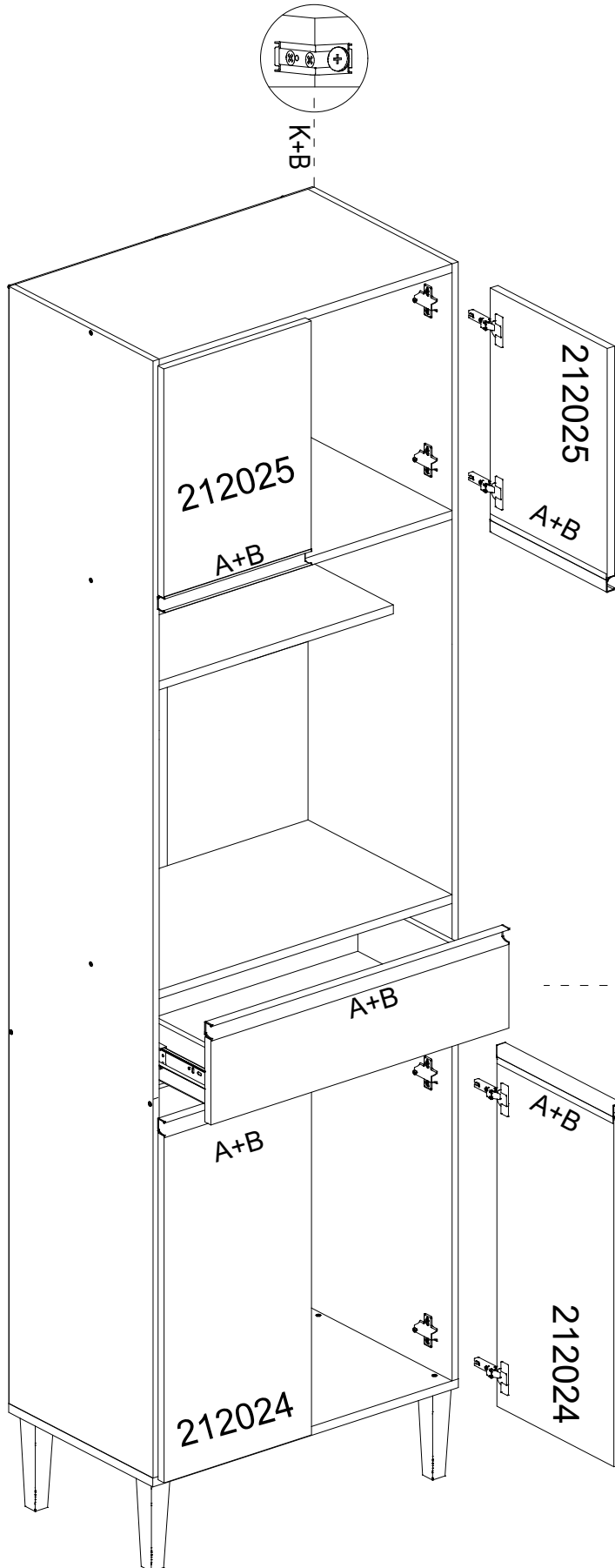

FIXAR A DOBRADIÇA NA PORTA COMO MOSTRA O DESENHO AO LADO.

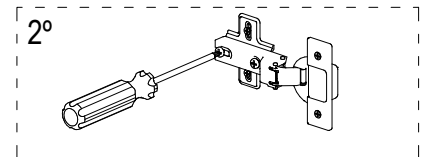

FAZER A JUNÇÃO DA DOBRADIÇA COM O CALÇO E APERTAR O PARAFUSO CENTRAL.

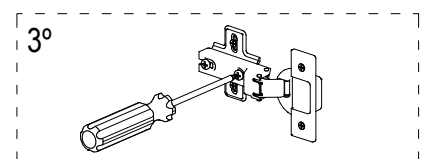

APÓS A JUNÇÃO FECHAR A PORTA E FAZER A REGULAGEM PRECISA.