

# ESQUEMA DE MONTAGEM

**PRODUTO**  
ARMARIO MULTIUSO NEW

**CÓDIGO**  
2000192

MARTELO

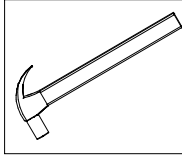

CHAVE PHILIPS

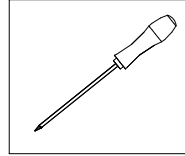

PARAFUSADEIRA

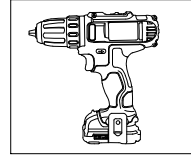

**GARANTIA**  
**90**  
**DIAS**

-EM CASO DE ASSISTÊNCIA INDICAR O CÓDIGO DO PRODUTO, CÓDIGO DA COR E O CÓDIGO DA PEÇA DANIFICADA

REFERÊNCIA - 505 BRANCO TX NOVO	REFERÊNCIA - 900 ATACAMA	REFERÊNCIA - 910 ATACAMA-OFFWHITE	REFERÊNCIA - 926 ATACAMA-GRAFITE	MEDIDAS E DESCRIÇÃO	QTDE.
192921/505	192921/900	192921-900	192921-900	LATERAL DIR - 1700 X 305 X 12	1
192922/505	192922/900	192922-900	192922-900	LATERAL ESQ - 1700 X 305 X 12	1
192923/505	192923/900	192923/900	192923-925	PORTA - 1565 X 251 X 12	2
192924/505	192924/900	192924/900	192924/900	TAMPO / BASE - 0496 X 305 X 12	2
192925/505	192925/900	192925/900	192925/900	PRAT - 0496 X 254 X 12	3
192926/505	192926/900	192926/900	192926/900	RODAPE FRONTAL - 0496 X 080 X 12	1
192927/999	192927/999	192927/999	192927/999	RODAPE TRASEIRO - 0496 X 080 X 12	1
192928/505	192928/900	192928/900	192928/900	VISTA SUP - 0496 X 056 X 12	1
192901/505	192901/900	192901/900	192901/900	FUNDO TRAS - 1560 X 247 X 03	2
192929/505	192929/900	192929/900	192929/900	PERFIL MADEIRA - 1540 X 035 X 12	1

## CORES

**CÓD. DESCRIÇÃO**  
505 - BRANCO TX NOVO  
900 - ATACAMA  
910 - ATACAMA - OFFWHITE  
926 - ATACAMA - GRAFITE

## DIMENSÕES DO PRODUTO

ALTURA: 1700mm  
LARGURA: 520mm  
PROFUNDIDADE: 320mm

## ASPECTO FINAL

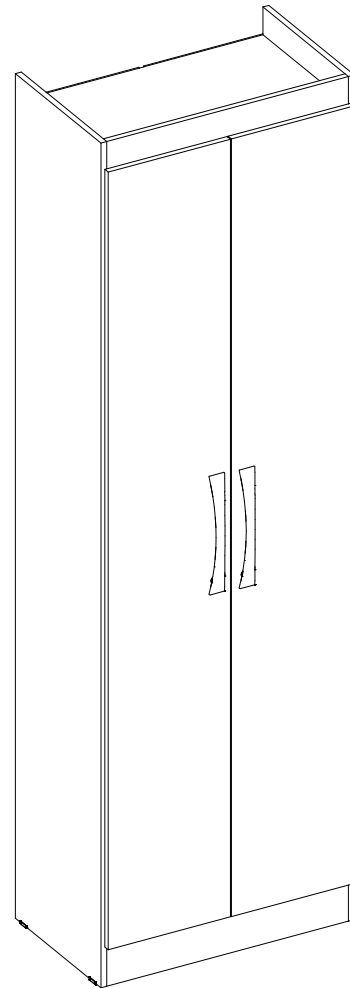

Fone: (43) 3274-8600 Fax (43) 3274-8601  
Fone: (Assistência Técnica) 0800 707 2455  
Rua: Gaturamo Bandeira 145 - Pq Industrial 2  
CEP: 86703-290 Arapongas - Paraná  
E-Mail: aramoveis@aramoveis.com.br  
www.aramoveis.com.br



Depósito Guarulhos-SP  
Rua: Junqueiro, N° 298 CEP: 07210-130  
Jardim Arapongas (Estrada Velha de São Miguel)  
Fone: (11) 4803-4691  
Fone: (11) 4803-4697  
Whats: (43) 99914-0493  
aramoveissp@aramoveis.com.br

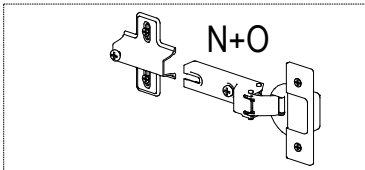

FIXAR A DOBRADIÇA NA PORTA COMO MOSTRA O DESENHO AO LADO.

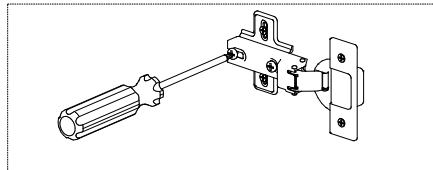

FAZER A JUNÇÃO DA DOBRADIÇA COM O CALÇO E APERTAR O PARAFUSO CENTRAL.

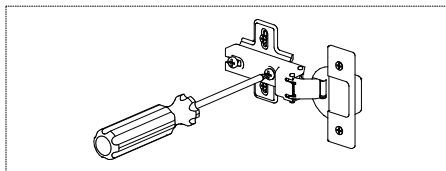

## OS PARAFUSOS ESTÃO ESCALA DE TAMANHO REAL PARA MELHOR IDENTIFICAÇÃO



**A - 32006**

PARAFUSO 3.5X12MM - 24pçs

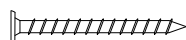

**B - 32050**

PARAFUSO 3.5X25MM - 4pç

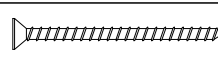

**C - 32048**

PARAFUSO 3.0X30MM - 3pç

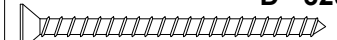

**D - 32049**

PARAFUSO 3.5X40MM - 6pç

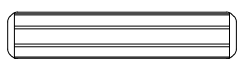

**E - 45000**

CAVILHA 6.0X30MM - 30pç



**F - 32004**

PREGO 08X08MM - 50pç

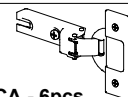

**G - 38006**

DOBRADIÇA - 6pçs



**H - 38007**

CALÇO 5MM - 6pçs



**I - 46030**

JUNTA P-DOBRADIÇA. - 6pçs

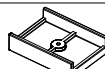

**J - 37016**

SAPATA 15X18MM - 4pçs



**K - 39008**

PUXADOR PLAST. TURIM - 2pç

### MONTAGEM PASSO A PASSO

- 1° - É ACONSELHÁVEL FERRAR O CHÃO PARA MONTAGEM;
- 2° - É ACONSELHÁVEL MONTAR O PRODUTO DEITADO ONDE A FRENTE DO MESMO FIQUE PARA BAIXO;
- 3° - MONTAR TODAS AS PARTES CONFORME O ESQUEMA DE MONTAGEM;
- 4° - AS PORTAS E RODAPÉ SÃO AS ÚLTIMAS A SER FIXADAS;
- 5° - É NECESSÁRIO 02 PESSOAS PARA MONTAGEM.

#### 1° - PREPARAÇÃO DAS PEÇAS

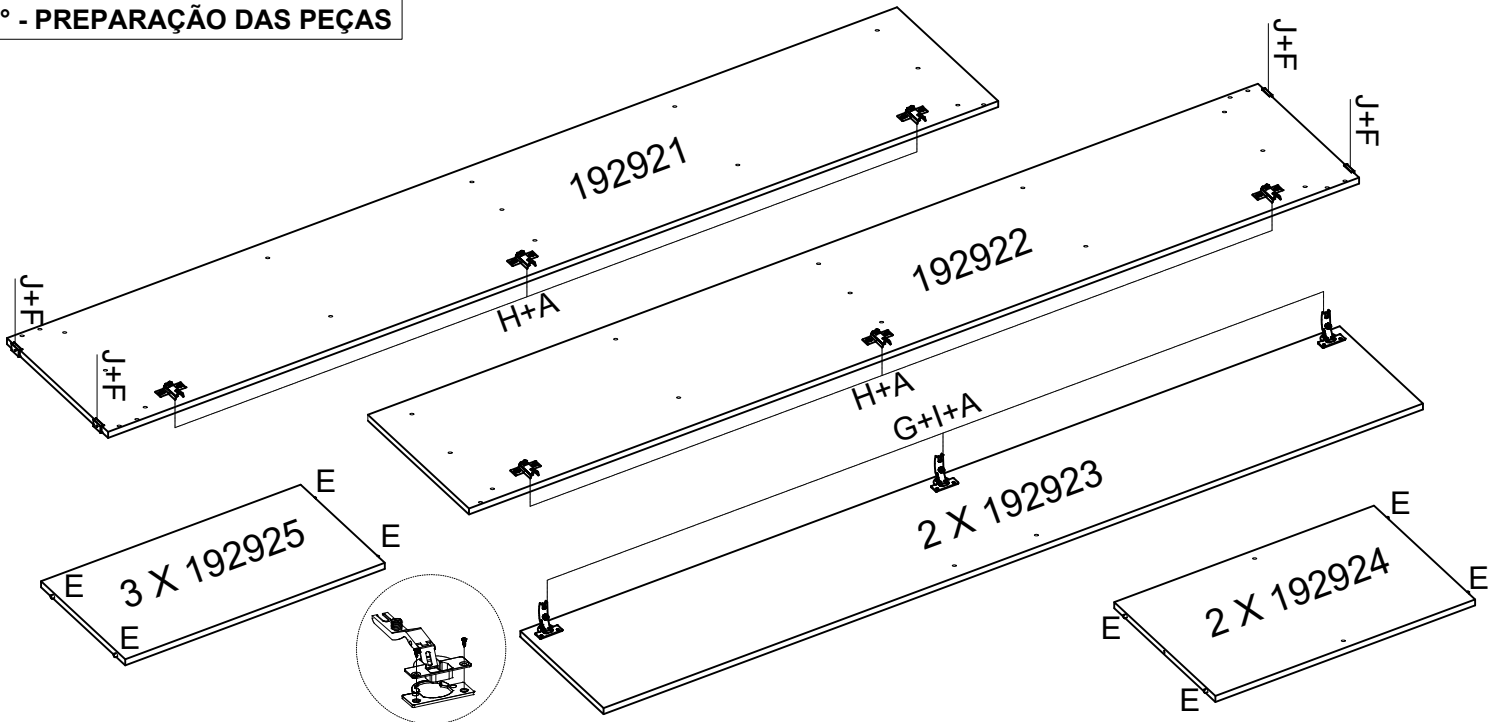

#### 2° PASSO

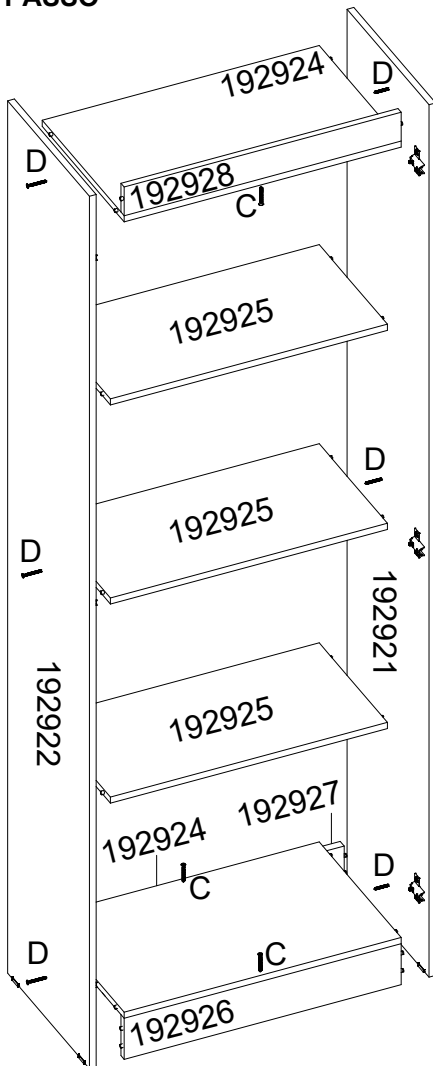

#### 3° PASSO

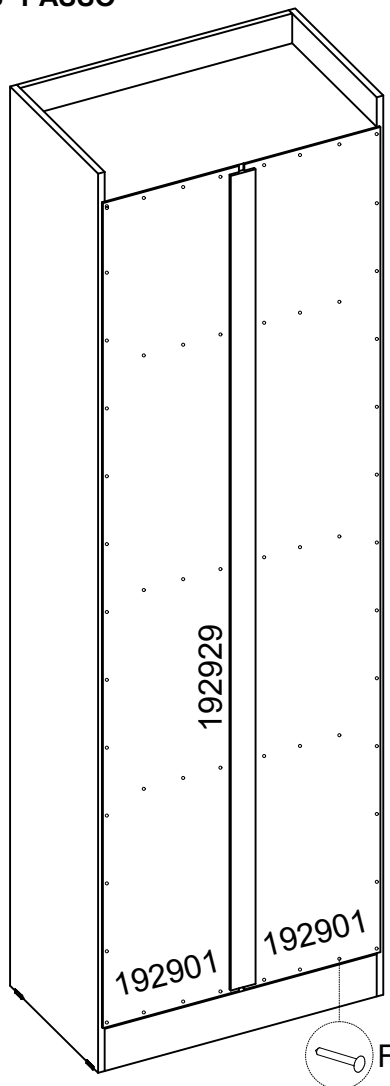

#### 4° PASSO

